

继电器附件系列

Accessories

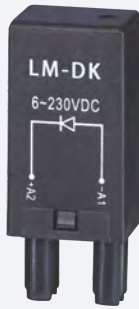

LM-EL



LM-DK

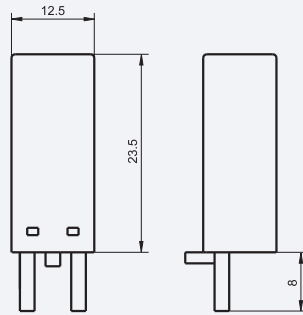

适用插座型号:

- 14F-2Z-C2/C3/C4/C5
- 14F-1Z-C2/C3/C5
- 157F-1Z-C3
- 157F-2Z-C3
- 18F-4Z-C4/C5/C8/C9
- 18F-3Z-C4/C5
- 18F-2Z-C4/C5/C8/C9

插入式LED模块

LED Module

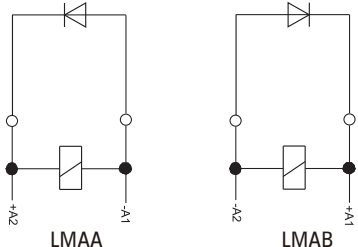
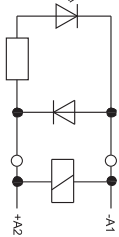
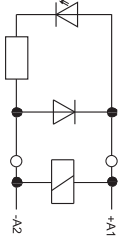
分类 Area	型号 Model	电路图 Circuit diagram	电压 Voltage	内置元件 Built-in components
A	LM-AA		(6~220)VDC	二极管 Diode
	LM-AB		(6~220)VDC	
B	LM-BC® LM-BC(G)		(6~24)VDC	二极管 Diode LED LED 电阻 Resistor
	LM-BD® LM-BD(G)		(24~60)VDC	
	LM-BE® LM-BE(G)		110VDC	
C	LM-CF® LM-CF(G)		(6~24)VDC	二极管 Diode LED LED 电阻 Resistor
	LM-CG® LM-CG(G)		(24~60)VDC	
	LM-CH® LM-CH(G)		110 VDC	

插入式LED模块
 LED Module

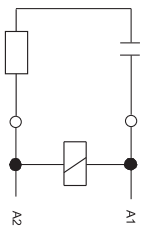
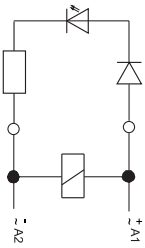
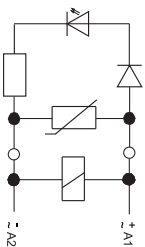
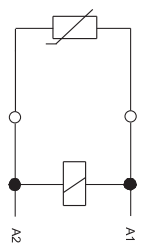
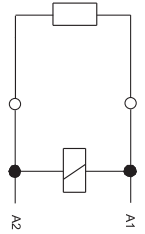
分类 Area	型号 Model	电路图 Circuit diagram	电压 Voltage	内置元件 Built-in components
D	LM-DI		(6~24) VAC/DC	电容 Capacitance 电阻 Resistance
	LM-DJ		(24~60) VAC/DC	
	LM-DK		(110~230) VAC/DC	
E	LM-EL(R) LM-EL(G)		(6~24) VAC/DC	二极管 Diode LED LED 电阻 Resistor
	LM-EM(R) LM-EM(G)		(24~60) VAC/DC	
	LM-EN(R) LM-EN(G)		(110~230) VAC/DC	
F	LM-FO(R) LM-FO(G)		(6~24) VAC/DC	二极管 Diode LED LED 电阻 Resistor 变阻器 Rheostat
	LM-FP(R) LM-FP(G)		(24~60) VAC/DC	
	LM-FQ(R) LM-FQ(G)		(110~230) VAC/DC	
G	LM-GR		24VAC	变阻器 Rheostat
	LM-GS		115VAC	
	LM-GT		230VAC	
M	LM-HU		(110~230) VAC/DC	电阻 Resistor

采用二极管保护线圈，可消除逆向电流
 Diode protection coil to eliminate reverse current

采用LED显示线圈通电状态
 Use LED to display coil energization status

备注：当模块中含有LED内置元件时，请在订货标记后标注(R)或(G)表示指示灯颜色，如LM-BC(R)或LM-BC(G)，其中(R)表示红色，(G)表示绿色。
 Note: When the module contains LED built-in components, please mark (R) or (G) after the order mark to indicate the color of the indicator light, such as LM-BC(R) or LM-BC(G), where (R) means red, (G) Indicates green.